

Landmark® Series and Landmark® TL

12

YOUR OBJECTIVE:

To learn the correct procedure for installing Landmark® shingles.

LANDMARK SERIES AND LANDMARK TL

Landmark shingles have the installer-friendly NailTrak® feature, which provides **1½" wide nailing area** and specially formulated Quadra-Bond laminating adhesive (See Figure 12-3).

Landmark Special is impact resistant and is specially manufactured with a reinforced fiberglass scrim to meet UL 2218 Class 4 impact resistance rating.

NOTE: Landmark Special must be installed over a clean deck (no roof-overs) to obtain the UL 2218 rating. It is strongly recommended that impact resistant cap shingles made from XT 30 IR shingles be installed on all hips and ridges. Some insurance carriers may not consider the roof system as compliant to UL 2218 Class 4 without impact resistant cap shingles.

Landmark Solaris shingles are ENERGY STAR® qualified roof products that meet both solar reflectance and thermal emissivity requirements. Using CertainTeed's advanced roofing granules, Landmark Solaris reflects solar energy and radiates heat far better than traditional roofing shingles – it can reduce the roof's temperature by as much as 20 percent in the summer. **NOTE:** Use matching Landmark Solaris hip and ridge shingles which are also solar reflective.

Landmark TL is unique because its patented Tri-Laminate™ design combines three layers of material to provide a dramatically thick shingle with a wood shake style.

With the exception of Landmark TL, closed-cut valleys are preferred by CertainTeed when applying these shingles; however, open valleys are also acceptable. **Open valleys are recommended when applying Landmark TL;** however closed-cut valleys are also acceptable. Woven valleys are not recommended for Landmark TL because the tri-laminated shingle can buckle and become damaged when shaped into the valley. **Nails are required as fasteners for Landmark TL,** staples are not allowed.

STANDARD OR STEEP SLOPES: CertainTeed recommends DiamondDeck® Synthetic Underlayment, Roofers' Select® High Performance Underlayment, or shingle underlayment meeting ASTM D226, D4869 or D6757. Take care to ensure sufficient deck ventilation when DiamondDeck or other synthetic underlayment is installed. Follow manufacturer's application instructions.

LOW SLOPES: One layer of CertainTeed's WinterGuard® Waterproofing Shingle Underlayment (or equivalent, meeting ASTM D1970) or two layers of 36" wide felt shingle underlayment (Roofers' Select or underlayment product meeting ASTM D226, D4869 or D6757) lapped 19" must be applied over the entire roof; ensure sufficient deck ventilation. When DiamondDeck or other synthetic underlayment is installed, weather-lap at least 20" and ensure sufficient deck ventilation.

IMPORTANT: When installing LandMark TL on low slopes, one layer of WinterGuard or an equivalent waterproofing shingle underlayment must be applied over the entire roof. **Applying two layers of felt shingle underlayment is not an acceptable alternative to WinterGuard.** One layer of shingle underlayment meeting ASTM D4869 applied over the required WinterGuard is also recommended.

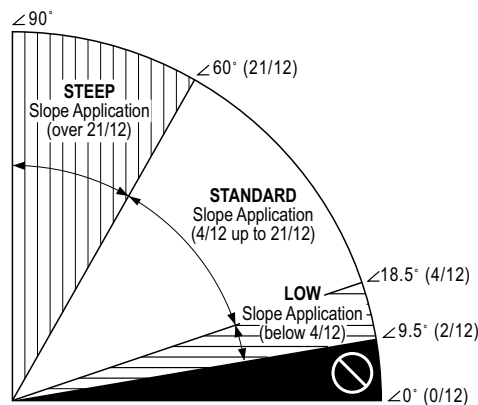

Figure 12-1: Slope definitions.

THE ROOF DECK* MUST BE AT LEAST: 3/8" (9.5 mm) thick plywood, or 7/16" (11 mm) thick non-veneer, or nominal 1" (25 mm) thick wood deck.

COLD WEATHER CLIMATES (ALL SLOPES): Application of WinterGuard or its equivalent is strongly recommended whenever there is a possibility of ice build-up. Follow manufacturer's application instructions.

FLASHING: Corrosion-resistant flashing must be used to help prevent leaks where a roof meets a wall, another roof, a chimney or other objects that penetrate a roof.

SEALING: Shingle sealing may be delayed if shingles are applied in cool weather and may be further delayed by airborne dust accumulation. If any shingles have not sealed after a reasonable time period, hand sealing may be necessary.

CAUTION: To prevent cracking, shingles must be sufficiently warm to allow proper forming for hips, ridges and valleys.

WARRANTY: These shingles are warranted against manufacturing defects and are covered by SureStart™ protection. See the warranty itself for specific details and limitations.

*

For technical questions, information on acceptable alternative application methods and materials, or a copy of the product warranty, contact the sources listed below:	Warranty	Alternate Instructions	Technical Questions
Your supplier or roofing applicator	✓		
CertainTeed Home Institute 800-782-8777	✓	✓	
CertainTeed-RPG Technical Services 800-345-1145	✓	✓	✓

FASTENING

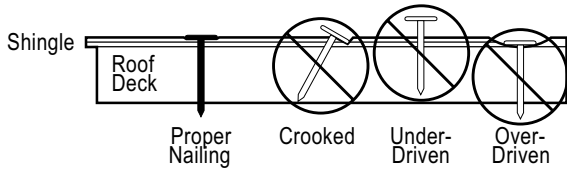

Figure 12-2: Proper and improper nailing.

IMPORTANT: For decks $\frac{3}{4}$ " (19 mm) thick or thicker, nails must go at least $\frac{3}{4}$ " (19 mm) into the deck. On thinner decks, nails must go at least $\frac{1}{8}$ " (3.2 mm) through the deck.

Nails must be 11- or 12-gauge roofing nails, corrosion-resistant, with at least $\frac{3}{8}$ " (9.5 mm) heads, and at least 1" (25 mm) long.

LandMark TL requires nails at least $1\frac{1}{4}$ " long.

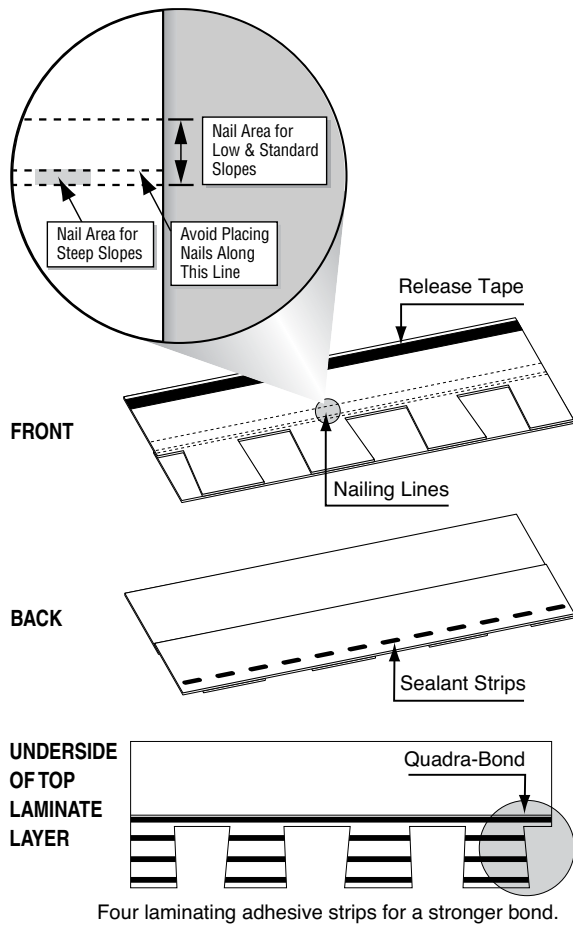
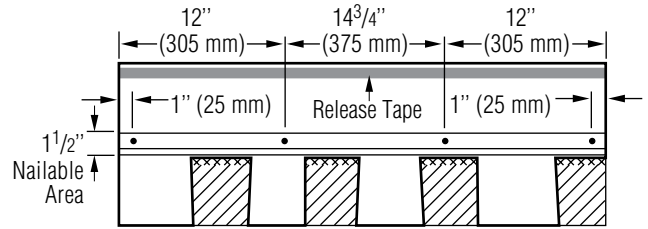

Figure 12-3: NailTrak® features a wider nail area and extra-strong Quadra-Bond construction.

LOW AND STANDARD SLOPE

LANDMARK



LANDMARK TL

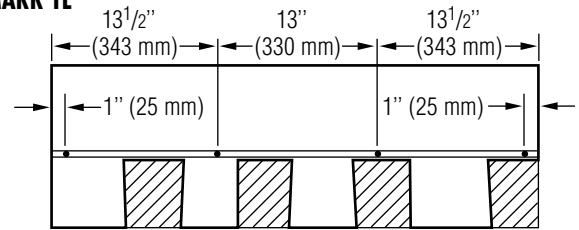
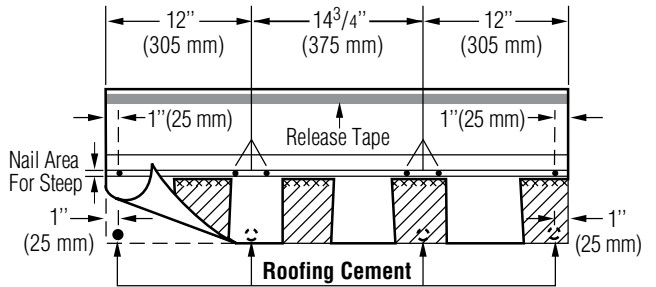

Figure 12-4: Use four nails for every full shingle.

STEEP SLOPE

Use six nails and four spots of asphalt roofing cement for every full laminated shingle. See below. Asphalt roofing cement should meet ASTM D 4586 Type II. Apply 1" spots of asphalt roofing cement under each corner and at about 12" to 13" in from each edge.

LANDMARK



LANDMARK TL

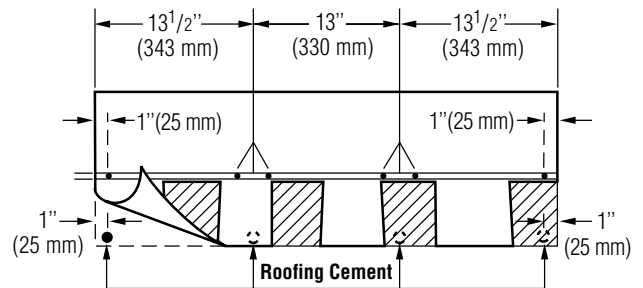

Figure 12-5: Use six nails and four spots of asphalt roofing cement on steep slopes.

CAUTION: Excessive use of roofing cement can cause shingles to blister.

TWO CLEAN-DECK APPLICATION METHODS FOR LANDMARK AND LANDMARK TL SHINGLES

FIVE-COURSE DIAGONAL METHOD (6" AND 11") FIVE-COURSE DIAGONAL METHOD (5⁵/₈" AND 11¹/₄")

NOTE: The 6" and 11" method is shown below. The 5⁵/₈" and 11¹/₄" method follows the same application instructions as the 6" and 11" method except the dimensions of the shingle cut-offs in the second and third courses are 5⁵/₈" and 11¹/₄" respectively.

CAUTION: Use of other installation methods may result in an objectionable pattern.

PREPARING THE DECK:

- ◆ Apply underlayment as required. CertainTeed suggests that a layer of shingle underlayment be applied. For UL fire rating, underlayment is generally required. Apply flat and unwrinkled.
- ◆ Snap chalklines to assure shingles will be correctly aligned. Expose all shingles 5⁵/₈" (143 mm).

STARTER COURSE:

1. Use CertainTeed Swiftstart® Starter, or three-tab self-sealing shingles with the lower tab portions removed. Be sure that the starter shingles are at least 7⁵/₈" in height. (Figure 12-6).

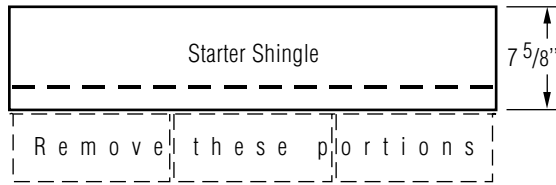

Figure 12-6: Make starter shingles that are 7⁵/₈" in height.

2. For the first starter, cut 6" from one side of the starter shingle.
3. Apply the remaining piece to the lower left corner of the roof. Make sure there is ¹/₂" overhanging the rakes and eaves if drip edge is being used. If you are not using drip edge, make the overhang ³/₄".
4. Use full length starter shingles for the rest of the course.

1ST COURSE: Apply a full shingle at the lower left corner of the roof. Make the lower edge and left edge lie flush with the edges of the starter course (Figure 12-7).

2ND THROUGH 5TH COURSES:

CAUTION! Failure to follow instruction steps 1-5 below will bring joints too close together and may cause unattractive patterns!

1. Cut 6" off the left end of the first shingle and save this piece for later use. Apply the 32³/₄" (34" for Landmark TL) long piece over and above the first-course shingle. Leave the bottom 5⁵/₈" tab portion of the first-course shingle exposed.
2. Cut 11" off the first shingle of the third course and save this for later. Install the 27³/₄" (29" for Landmark TL) long piece over and above the second-course shingle.
3. Apply the previously removed 11" long piece over and above the third-course shingle.
4. Apply the previously removed 6" long piece from the second course over and above the fourth-course shingle.
5. Install a full shingle against the right edge of each shingle in courses one through five.

CONTINUING UP THE ROOF:

1. Beginning again with a full shingle, repeat the five-course pattern up the left rake. (Figure 12-8, B).
2. Fill-in courses across the roof in a stepped diagonal fashion using full shingles. (Figure 12-8, A). Do **not** run courses straight across.

IMPORTANT: Do not align joints of shingles closer than 3¹/₂" from one another.

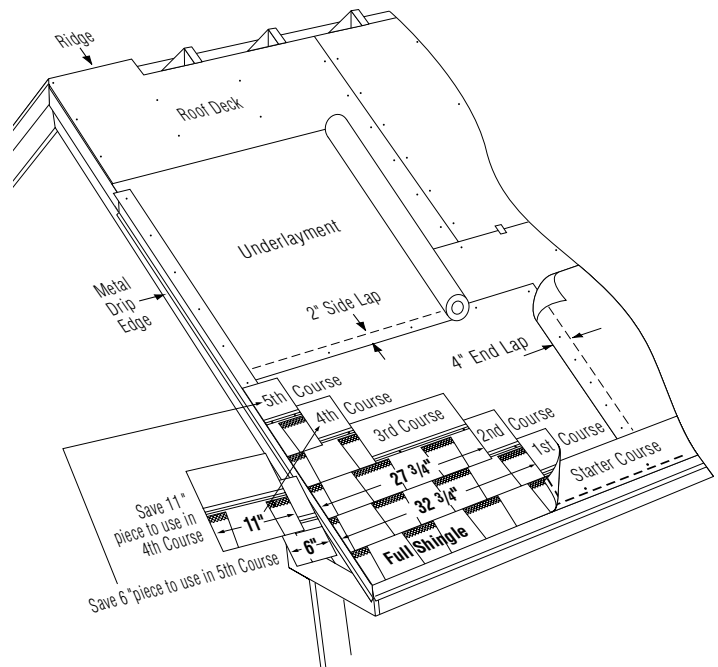

Figure 12-7: Applying the first 5 courses of Landmark.

Note: The LandMark TL dimensions differ.

Figure 12-8: "Five-Course Diagonal Method" installation schematic.

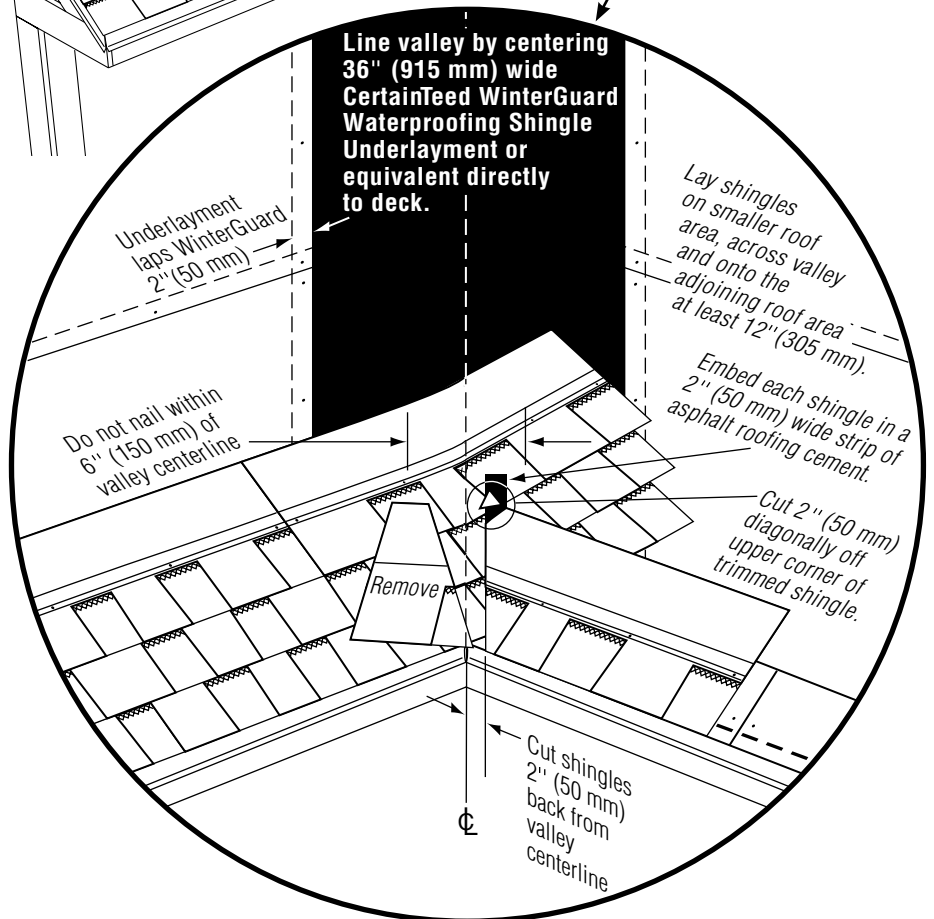
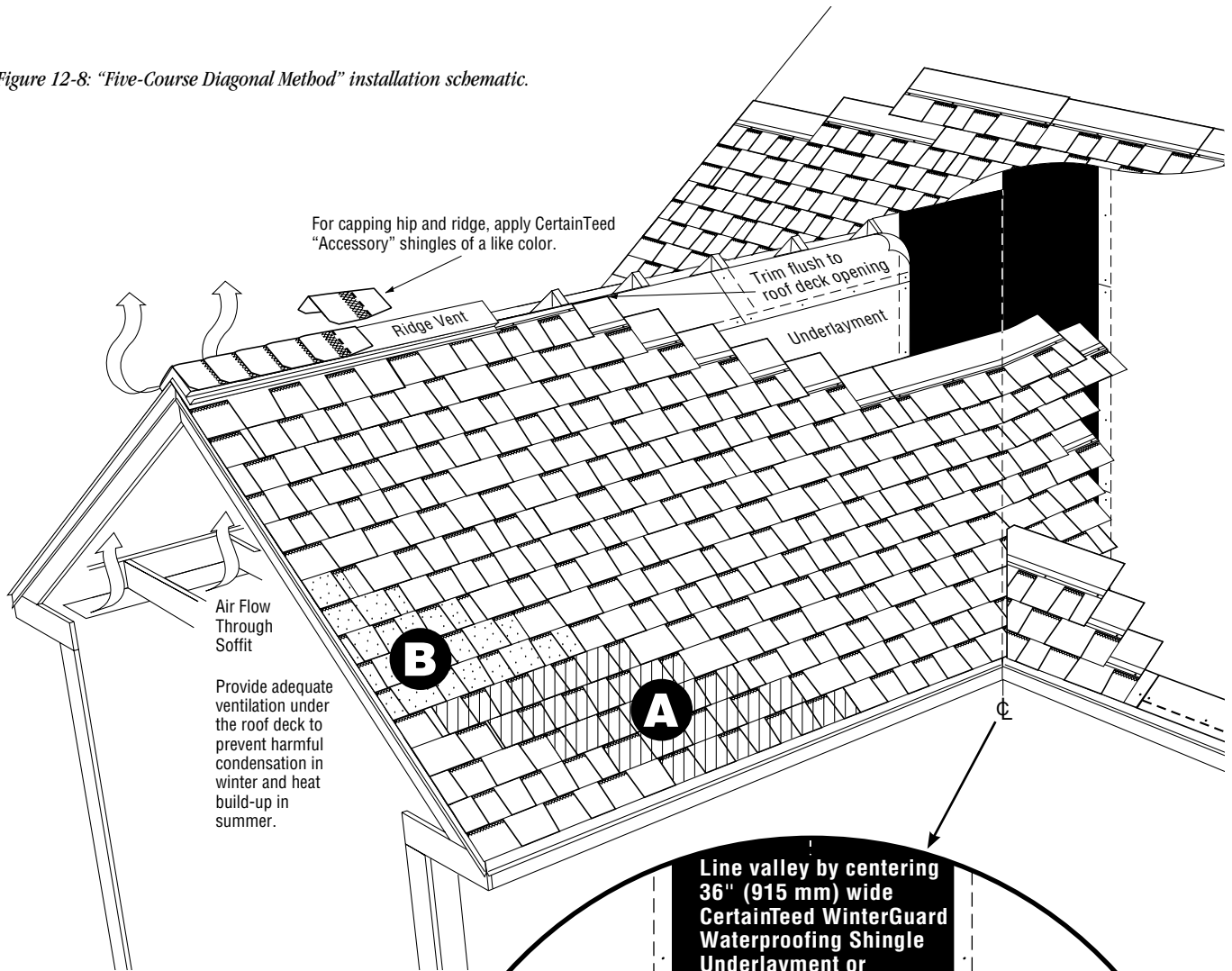

Figure 12-9: Highlight of closed-cut valley details.

CHIMNEY FLASHING

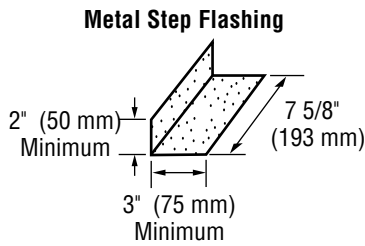

Figure 12-10: Step flashing minimum dimensions.

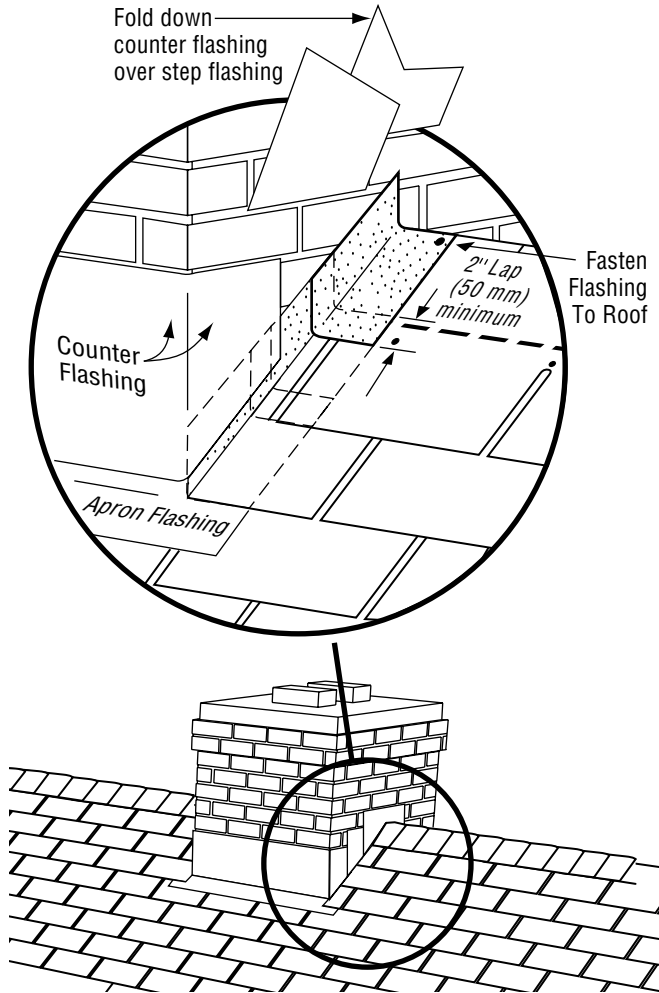

Figure 12-11: Flashing around a chimney.

TWO ROOF-OVER METHODS FOR LANDMARK AND LANDMARK TL SHINGLES

The same methods used for clean-deck application of these shingles are used for roof-overs. Application of these shingles *over* English dimension shingles is not recommended — due to the high cost of workmanship and greater risk of worker error.

HIPS AND RIDGES

SHADOW RIDGE® ACCESSORY SHINGLES

Shadow Ridge shingles have an accented shadow line that is designed to complement these shingles. Simply fold along the pre-cut lines and detach individual cap pieces. Save valuable installation time compared to cutting 3-tab shingles.

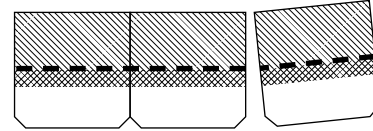

Figure 12-12: Shadow Ridge accessory shingles detach easily from three-piece units to make 72 individual cap pieces.

There are 24 three-piece units in each Shadow Ridge bundle, providing 72 individual caps that will cover 30 linear feet (33³/₄ linear feet, Metric) of a hip or ridge. Each English dimension cap piece is 12" by 12" (Metric caps are 13¹/₄" by 9⁷/₈") and features clipped corners on the bottom edge of the exposed portion.

APPLICATION IS AS FOLLOWS:

1. Apply shingles up to the hip or ridge on both sides, then trim flush.

NOTE: The last course of shingles should have an exposure of 5" (5⁵/₈" for metric) or less when the shingle cap or ridge vent is fastened in place. Otherwise, a potential water leak could occur at exposed shingle end joints. The figures used in this section illustrate the application of accessory shingles over a ridge vent; application directly to the roof deck is very similar.

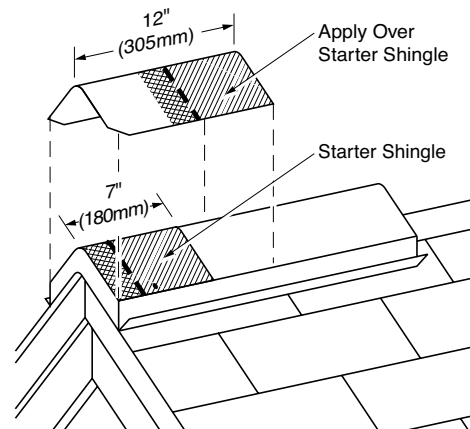

Figure 12-13: Apply a full cap shingle over the starter piece, flush with the bottom and side edges of the starter.

2. Install caps beginning at the bottom of a hip or at either end of a ridge. Apply a starter piece that has the bottom 5" (5⁵/₈" for metric) removed (Figure 12-18). Fasten the starter with two nails located about 3" from the rake edge, and 1" in from each side edge. Make sure fasteners used to apply caps penetrate at least 3/4" into or through the decking.

NOTE: To assist in proper alignment when ridge vent is not used, snap a chalk line parallel to the hip or ridge along the line where the side edges of the cap shingles should be.

3. Apply a full cap shingle over the starter (Figure 12-18), and place fasteners at $5\frac{5}{8}$ " ($6\frac{1}{4}$ " for metric) up from the exposed bottom edge and 1" in from each side. Nails must not be exposed on the finished roof. All nail heads must be driven straight and must not cut into the shingle surface.

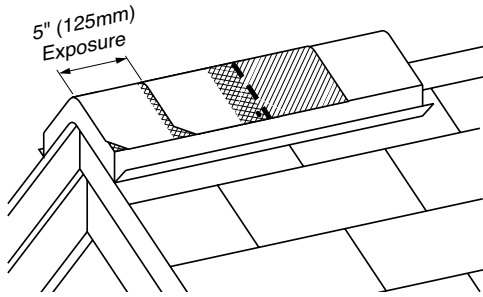

Figure 12-14: Install cap shingles at their correct exposure and cover all fasteners.

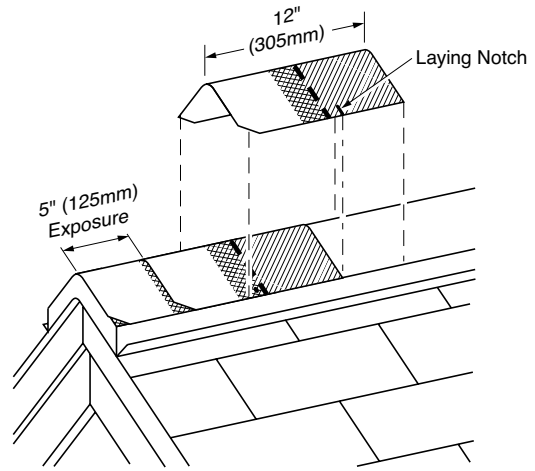
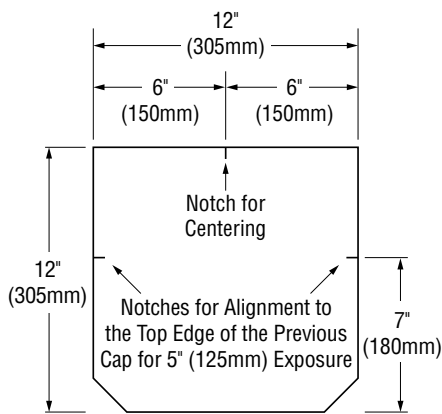
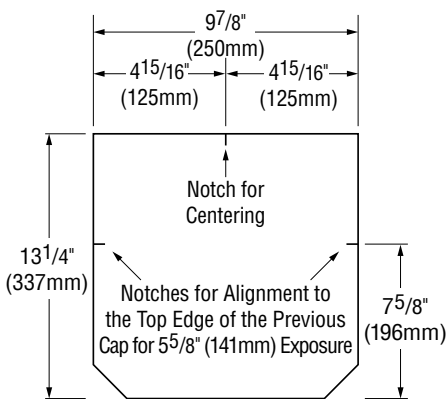

Figure 12-16: Use laying notches to center shingles on hips and ridges, and to locate the correct exposure.

NOTE: Each cap has a laying/alignment notch at the top edge to center the piece on the ridge line, and two notches on each side to indicate the correct exposure and shadow-line placement (Figure 12-19). The side notches of the cap being applied should be aligned with the top edge of the previously applied cap.



English Dimension



Metric Dimension

Figure 12-15 : Each Shadow Ridge® shingle has a centering notch and two side-alignment notches to help ensure proper placement

MOUNTAIN RIDGE HIGH-PROFILE HIP AND RIDGE ACCESSORY

Use Mountain Ridge® accessory shingles to cover hips, ridges or rake edges. One box will cover 20 linear feet. To prevent damage to shingles during application, they must be sufficiently warm to allow proper forming.

FASTENING

IMPORTANT: Use two nails to fasten each shingle. Nails must be **minimum 1 $\frac{3}{4}$ " (45 mm) long**. For the 4" (100 mm) starter shingle, place fastener 1" (25 mm) in from each side edge and about 2" (50 mm) from the rake (or eave) edge, making sure the fastener goes $\frac{3}{4}$ " into the deck or all the way through. For each full Mountain Ridge shingle, place fasteners $8\frac{3}{8}$ " (219 mm) up from its exposed butt edge and 1" (25 mm) in from each side edge.

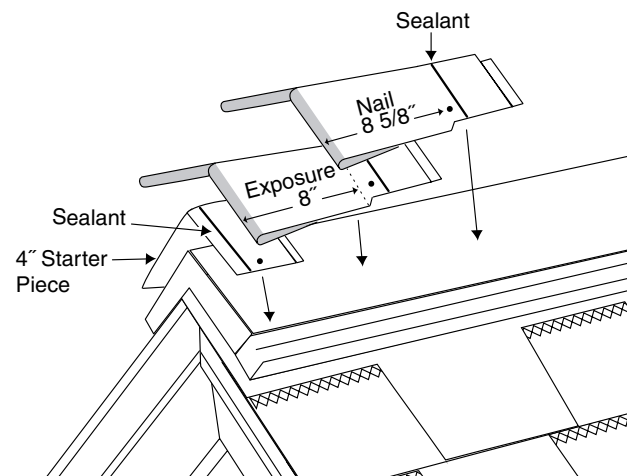

Figure 12-17: Hip and ridge application.

HIP, RIDGE AND RAKE SHINGLE APPLICATION

Apply the primary field roofing up to the hip or ridge from both sides of the roof and trim flush or lap over one side, not more than half the width of a Mountain Ridge® shingle.

Assure that the installed Mountain Ridge shingles properly cover hip and ridge field shingles on both sides and the field shingles applied along rake edges. For a rake edge installation, cut the field shingles flush to the rake edge. Apply Mountain Ridge shingles ensuring they fit securely against the rake board. **To assist in proper alignment, snap a chalk line parallel to the hip, ridge or rake along the line where the side edges of the Mountain Ridge shingles should fall.**

Prepare a 4" **Starter shingle** by cutting off the lower 8" color granule butt portion of one Mountain Ridge shingle. Apply the 4" starter piece (with sealant nearest the outer edge) over the bottom corner of the hip or rake, or on either end of the ridge, overhanging the corner or end by approximately 1/2" and bending the starter shingle along its centerline to form into place (see figures below.) Install a nail on each side about 2" up from the starter shingle's exposed butt edge and 1" in from each side edge of the shingle. The 8" piece that was cut off may be used to finish the opposite end of hip, ridge or rake.

Next, apply a full Mountain Ridge shingle over the installed starter shingle, bending it along its centerline and forming into place over the hip, ridge or rake, flush with the bottom and side edges of the starter shingle. Install a nail on each side of the shingle 8 5/8" up from the bottom edge and 1" in from each side edge.

Continue application of the Mountain Ridge shingles along the hip, ridge or rake as shown. Expose Mountain Ridge shingles 8", covering all fasteners.

CEDAR CREST MEDIUM-PROFILE HIP AND RIDGE ACCESSORY SHINGLES

Use Cedar Crest® accessory shingles to cover hips and ridges. Carefully separate the three-piece units prior to application, by first folding along the pre-cut lines and then detaching the pieces (see Figure 12-18). No cutting is necessary. There are 30 individual shingles (10 three-piece units) in each bundle. One bundle will cover 20 linear feet. Each 12" x 12" shingle has a shadowline that is a design feature which is visible when applied properly. To prevent shingle damage during application, they must be sufficiently warm to allow proper forming.

Figure 12-18: Separate to make 3 cap shingles.

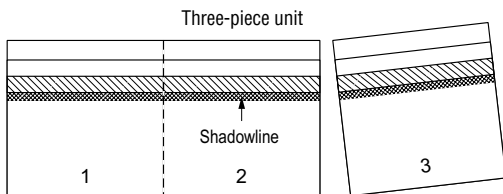

FASTENING

IMPORTANT: Use TWO nails to fasten each shingle. Fasteners must be minimum 1 3/4" (45 mm) long.

For the starter shingle, place fastener 1" in from each side edge and about 2" up from the starter shingle's exposed butt edge, making sure fastener goes 3/4" into the deck or all the way through the deck. (see Figure 12-19). For each full Cedar Crest shingle, place fasteners 8 5/8" up from its exposed butt edge and 1" in from each side edge (see Figure 12-20).

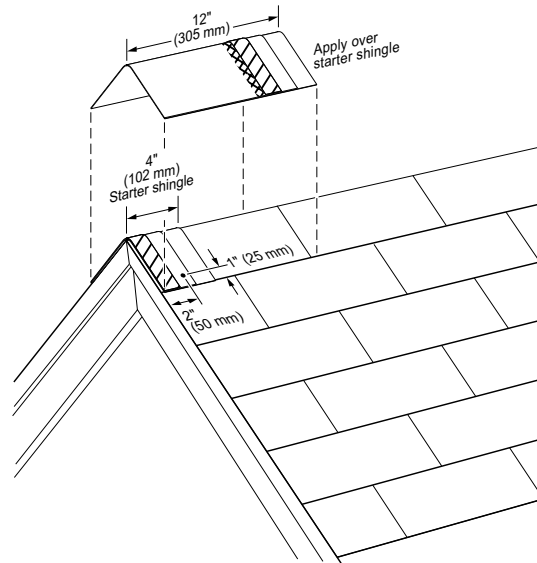

Figure 12-19: Apply a full cap shingle over the starter shingle.

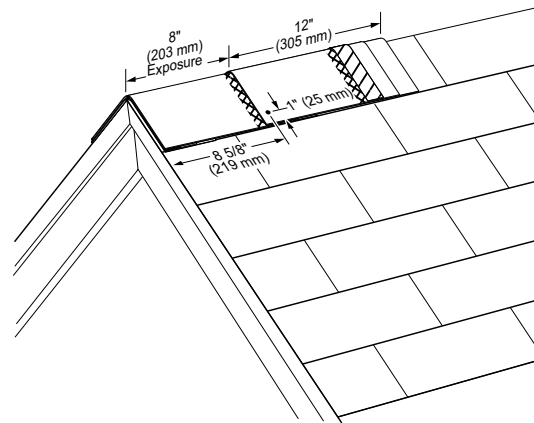

Figure 12-20: Install cap shingles at an 8" exposure and fasten with one nail on each side as shown.

IMPORTANT: High Wind Instructions. In order to achieve the ASTM D3161 Class “F” Wind Resistance Classification each “hip and ridge” shingle must be both 1) fastened with nails as shown and 2) hand-sealed with two 1/4" wide beads of either BASF “Sonolastic® NP1™ Adhesive” or Henkel “PL® Polyurethane Roof & Flashing Cement” applied from the middle of the shingle’s raised overlay on the top piece and extending approximately 4" along the sides of the headlap along a line 3/4"-1" in from each side edge of the shingle’s headlap as shown. Immediately align and apply the next overlying shingle, gently pressing tab sides into adhesive. Only one side of the double thickness tab is laminated together; to secure the other side, after folding the shingle over the ridge and nailing into position, a 1" diameter spot of either NP1 or PL adhesive must be applied between the shingle layers as shown. Immediately align and apply the next overlying shingle, gently pressing tab sides into adhesive.

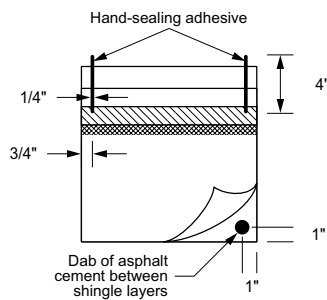

Figure 12-21: Hand seal caps as shown.

CEDAR CREST® APPLICATION

Apply primary roofing up to hip or ridge on both sides of roof and trim flush. Ensure that the Cedar Crest shingles will adequately cover the top course of the shingles on both sides of the hip or ridge. Prepare a 4" “starter” shingle by cutting off the lower 8" color granule portion of one Cedar Crest shingle. Apply the 4" starter piece with raised overlay edge over the bottom corner of the hip or to either end of the ridge, overhanging the corner or end by approximately 1/2" and bending the starter shingle along its centerline to form into place (see Figure 12-19). Install a nail on each side about 2" up from the starter shingle’s exposed butt edge and 1" in from each side edge of the shingle.

Then apply a full 12" x 12" piece over the starter, bending the shingle along its centerline and forming it into place over the hip or ridge, flush with the bottom and side edges of the starter shingle. Fasten with two nails minimum 1 3/4" long with one nail on each side of shingle 8 5/8" up from the butt edge and 1" in from each side edge (see Figure 12-20).

Continue application of Cedar Crest shingles up the hip or along the ridge, forming each shingle over the hip or ridge, and fasten as shown in Fastening. Expose Cedar Crest shingles 8", covering all fasteners.

To assist in proper alignment, snap a chalk line parallel to the hip or ridge applying along the line where the side edges of the Cedar Crest shingles should be.

Here’s a Tip... In the winter put hip and ridge cap shingles in your truck with the heater blasting for 20 minutes so the caps don’t crack when formed. (Thanks to Mark Dulz, Richmond, MI.)